

# 8201HRA Series

120V-60Hz

Catalog #:		Type
Project:		Date
Prepared by:		

## 4" Airtight Remodel Housing - LED and Incandescent Trims

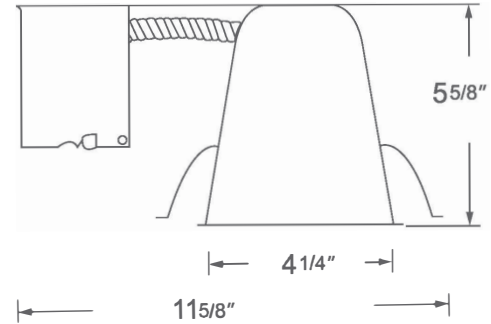

### DESCRIPTION

This 8201HRA Series is designed for quick and easy installation in existing ceilings. The housing is suitable for residential and commercial applications. Features thermal protection and spring-steel clips for easy installation.

### DESIGN FEATURES

#### Electrical

- 120V - 60 Hz
- LED Trims - Maximum 12W
- Incandescent Trims - Maximum 50W
- Thermally protected against improper lamping

#### Housing

- Sturdy aluminum construction
- Suitable for use in new construction applications
- 5-5/8" overall height allows use in 2" x 6" joist construction
- J-box is listed for through-branch circuit wiring (4in – 4out), with eight 1/2" knockouts
- 3-port quick connectors pre-installed in all J-boxes
- Adjusts to fit up to 1" ceiling thickness

#### Available Trims

- LED Trims: 8722, 8723, 8739, 8753-30, 8756, 8761, 8763, 8764, 8765, 8766, 8767, 8768, 8769, 8770, 8771, 8773
- Incandescent Trims: 8701, 8702

#### Dimensions

- Size: 5-5/8" H x 11-5/8" L x 4-1/4" W
- Opening: 4-1/4"

#### Certifications

- cETLus listed for damp location (wet trims available)
- Housing & Other Components: 1 Year Limited Warranty
- LED Lamps: 5 Year Limited Warranty

### ORDERING GUIDE

Example: 8201HRA

Model #
8201HRA
8201HRA (order trims separately)

TEL: 800.937.6925 | Fax: 800.207.9509 | [www.rplighting.com](http://www.rplighting.com)

Specifications and dimensions subject to change without notice.



6/13/22 R3

# 8201HRA Series

120V-60Hz

## LED Trim Ordering Information

### ORDERING GUIDE

Example: 8722WH-90-4K

Model #	Finish	CRI	CCT
	8722	WH	-90
	8722 4" Baffle with Lens 10W   650 lms	WH : White	-90 : 90 CRI

Limited quantities; check with factory

### ORDERING GUIDE

Example: 8723WH-90-3K

Model #	Finish	CRI	CCT
	8723	WH	-90
	8723 4" Baffle with Lens 9W   572 lms	WH : White	-90 : 90 CRI

### ORDERING GUIDE

Example: 8763WH-90-3K

Model #	Finish	CRI	CCT
	8763		-90
	8763 4" Reflector 10W   600 lms	<b>BK</b> : Black <b>BN</b> : Brushed Nickel <b>CL</b> : Clear <b>OB</b> : Oil Rubbed Bronze <b>WH</b> : White	-90 : 90 CRI -3K : 3000K -4K : 4000K

\* BK finish only available in -4K

### ORDERING GUIDE

Example: 8769WH-80-3K

Model #	Finish	CRI	CCT
	8769		-3K
	8769 4" Baffle with Lens 10W	<b>WH</b> : White <b>BK</b> : Black* <b>OB</b> : Oil Rubbed Bronze* <b>BA</b> : Brushed Aluminum	-80 : 80 CRI (889 lms) -90 : 90 CRI (710 lms)

\* - Only available in -80 CRI

### ORDERING GUIDE

Example: 8770CL-90-3K

Model #	Finish	CRI	CCT
	8770	CL	-3K
	8770 4" Clear Reflector 10W   710 lms	CL : Clear	-80 : 80 CRI* -90 : 90 CRI

\* Limited quantities; check with factory

### ORDERING GUIDE

Example: 8766BA

Model #	Finish
	8766
	8766 4" Baffle 10W   900 lms 3000K   90 CRI

Limited quantities; check with factory

TEL: 800.937.6925 | Fax: 800.207.9509 | [www.rplighting.com](http://www.rplighting.com)

Specifications and dimensions subject to change without notice.

6/13/22 R3

# 8201HRA Series

120V-60Hz

## LED Trim Ordering Information

### ORDERING GUIDE

Example: 8761BN-90-3K

Model #	Finish	CRI	CCT
 <b>8761</b> 4" Square Baffle 9W   630 lms		<b>-90</b>	<b>-3K</b>
	<b>BN</b> : Brushed Nickel <b>OB</b> : Oil Rubbed Bronze	<b>-90</b> : 90 CRI	<b>-3K</b> : 3000K

Limited quantities; check with factory

### ORDERING GUIDE

Example: 8773WH-90-3K

Model #	Finish	CRI	CCT
 <b>8773</b> 4" Square Baffle 11W   700 lms		<b>-90</b>	
	<b>BN</b> : Brushed Nickel <b>OB</b> : Oil Rubbed Bronze <b>WH</b> : White	<b>-90</b> : 90 CRI	<b>-3K</b> : 3000K <b>-4K</b> : 4000K

### ORDERING GUIDE

Example: 8765BN

Model #	Finish
 <b>8765</b> 4" Eyeball 8W   600 lms 3000K   90 CRI	
	<b>BN</b> : Brushed Nickel <b>OB</b> : Oil Rubbed Bronze <b>WH</b> : White

Limited quantities; check with factory

### ORDERING GUIDE

Example: 8768WH

Model #	Finish
 <b>8768</b> 4" Eyeball 10W   900 lms 3000K   90 CRI	
	<b>BN</b> : Brushed Nickel <b>OB</b> : Oil Rubbed Bronze <b>WH</b> : White

Limited quantities; check with factory

### ORDERING GUIDE

Example: 8753-30-BN

Model #	Finish
 <b>8753-30-</b> <b>8753-30-</b> 4" Gimbal 9W   520 lms 3000K   80 CRI	
	<b>BN</b> : Brushed Nickel <b>OB</b> : Oil Rubbed Bronze

Limited quantities; check with factory

### ORDERING GUIDE

Example: 8764BN

Model #	Finish
 <b>8764</b> 4" Gimbal 8W   600 lms 3000K   90 CRI	
	<b>BN</b> : Brushed Nickel <b>OB</b> : Oil Rubbed Bronze

Limited quantities; check with factory

TEL: 800.937.6925 | Fax: 800.207.9509 | [www.rplighting.com](http://www.rplighting.com)

Specifications and dimensions subject to change without notice.

# 8201HRA Series

120V-60Hz

## LED Trim Ordering Information

### ORDERING GUIDE

Example: 8771WH-90-4K

Model #	Finish	CRI	CCT
	8771	-90	
	8771 4" Gimbal 10W   717 lms <b>BN</b> : Brushed Nickel * <b>OB</b> : Oil Rubbed Bronze * <b>WH</b> : White **	-90 : 90 CRI	-3K : 3000K -4K : 4000K

Limited quantities; check with factory

\* only available in -3K

\*\* only available in -4K

### ORDERING GUIDE

Example: 8767OB

Model #	Finish
	8767
	8767 4" Gimbal 10W   900 lms 3000K   90 CRI <b>OB</b> : Oil Rubbed Bronze

Limited quantities; check with factory

### ORDERING GUIDE

Example: 8756WH-90-3K-R

Model #	Finish	CRI	CCT	Retrofit
	8739	-90		-R
	8739 4" Low Profile Disk 12W   722 lms <b>BK</b> : Black <b>BN</b> : Brushed Nickel <b>WH</b> : White	-90 : 90 CRI	-3K : 3000K	-R

### ORDERING GUIDE

Example: 8756WH-90-3K

Model #	Finish	CRI	CCT	Retrofit
	8756	-90	-3K	-R
	8756 4" Low Profile Disk 12W   710 lms <b>WH</b> : White <b>BK</b> : Black <b>OB</b> : Oil Rubbed Bronze <b>BN</b> : Brushed Nickel	-90 : 90 CRI	-3K : 3000K	-R

## Incandescent Trim Ordering Information (lamp not included)

### ORDERING GUIDE

Example: 8701WH

Model #	Finish
	8701
	8701 White Baffle 50W Max. PAR20/R20 <b>WH</b> : White

### ORDERING GUIDE

Example: 8702FS

Model #	Finish
	8702
	8702 Fresnel Shower Trim 35W Max. PAR20/R20 <b>FS</b> : Fresnel

TEL: 800.937.6925 | Fax: 800.207.9509 | [www.rplighting.com](http://www.rplighting.com)

Specifications and dimensions subject to change without notice.

6/13/22 R3